

Chapter 13. Material Handling Systems

This is an introduction chapter quotation. It is offset three inches to the right.

13.1. Material Handling Introduction

Material Handling Definition

Several definitions of Material(s) Handling exist. Materials Handling is defined in Compton's Interactive Encyclopedia as "The movement of raw materials, semi-finished goods, and finished articles through various stages of production and warehousing is called materials handling."

Material Handling is concerned with the movement, storage, and control of materials in a (production) process.

Material Handling and logistics are expensive operations which comprise of 10 % to 80 % of the product cost and this percentage tends to rise for inexpensive or commodity products. Physical distribution alone, i.e., the movement of products from the manufacturing plants to the customers, accounts for 25 % of the product cost. Internal to the plants, more than 90 % of the product flow time in a job shop is spent in material handling functions including waiting for an available machine.

Traditional and Modern Views

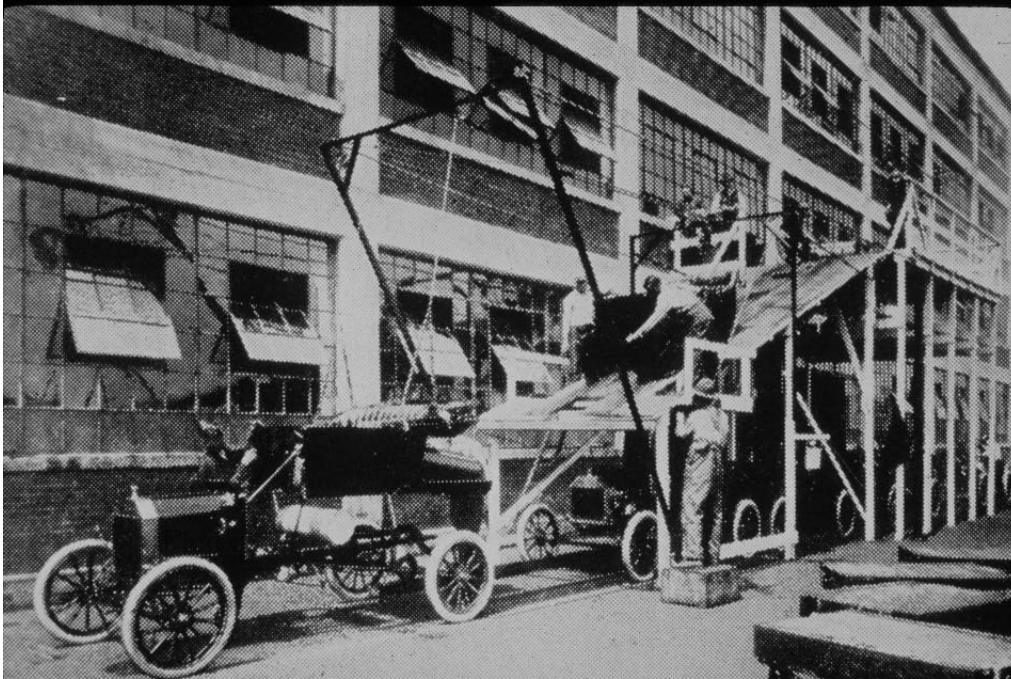

Figure 13.1 . Material Handling in Early Automotive Assembly

The traditional view of material handling sees material handling operations as non value-adding and only contributing to the cost of the product. As such, material handling should be avoided and minimized as much as possible. Since material handling operations often involve a substantial amount of direct labor and labor is expensive, many material handling design engineers were very supportive of automation. This trend is even more pronounced in Japan and Western Europe where labor is more expensive.

The modern view recognizes the space and time utility of material handling operations, i.e., a product is worth more if it is at the right place at the right time. The modern goals in material handling system design are to create a flexible system that can be used for a variety of products and processes and to integrate the currently designed material handling system in the overall material handling plan.

Stages in Material Handling System Design

1. WHY?
2. WHAT?

3. WHEN and WHERE?
4. HOW?
5. By WHOM?

13.2. Material Handling Classification

Classification by Material

Material Classes

1. Gasses
2. Liquids
3. Bulk Materials
4. Discrete Load Materials
5. Documents, Mail, and Money
6. Livestock
7. People

Unit Load

A unit load is very often used in the material handling of discrete load materials. A Unit Load is a collection of materials so arranged and restrained that it can be handled, stored, and controlled as a single entity.

The advantages of using a unit load are amongst others the uniform handling and uniform storage operations, the reduced burden on information and control systems. In addition, unit loads allow efficient (macro) external space utilization since each load is the same size and storage locations can be sized to accommodate this unit load and the loads can be packed tightly together without gaps.

The disadvantages of using a unit load are the cost of assembling and disassembling the unit load, the cost of the container and wrapping, and the cost of the empty returnable container handling or the

disposal cost of single use containers. In addition, unit loads can have an inefficient (micro) internal space utilization if the unit loads can be completely filled up.

Prime examples of unit loads are a pallet, drum, over the road truck and ocean going intermodal container. The last one is illustrated in Figure 13.43.

Classification by Method

Characteristics of Material Handling Methods

Table 13.1. Labor and Control Providers for Material Handling Methods

	Capability	
	Labor	Control
Type		
Manual	Human	Human
Mechanized	Machine	Human
Automated	Machine	Machine

Table 13.2. Material Handling Methods Characteristics

Characteristic	Type		
	Manual	Mechanized	Automated
Weight	Low	High	High
Volume	Low	High	High
Speed	Low	Medium	High
Frequency	Low	Medium	High
Capacity	Low	Medium	High
Flexibility	High	Medium	Low
Acquisition cost	Low	Medium	High
Operating cost	High	Medium	Low

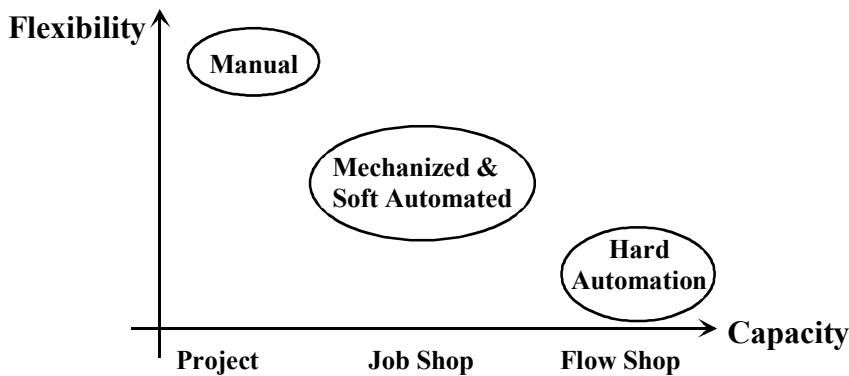

Figure 13.2. Material Handling Methods

Manual Material Handling



Figure 13.3. Illustrations of Manual Material Handling



Figure 13.4. Wheelbarrow as an Example Manual Material Handling Equipment

Mechanized Material Handling



Figure 13.5. Fork Lift as an Illustration of Mechanized Material Handling Equipment

Automated Material Handling

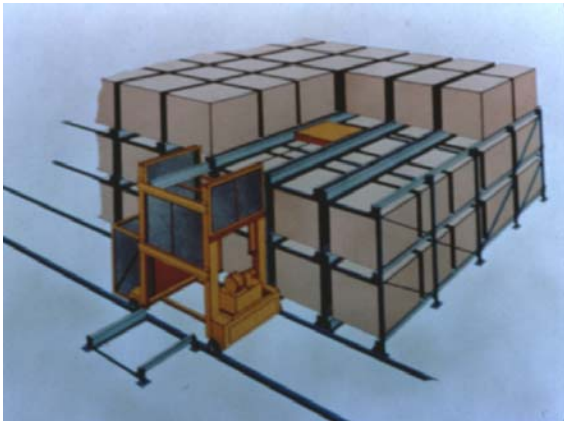

Figure 13.6. Deep Lane Storage as an Illustration of Automated Material Handling

Classification by Equipment Types

An extensive taxonomy has been created by the Material Handling Institute of America (MHIA), including drawings of many equipment types. It can be found at www.mhia.org/et/mhe_tax.htm.



Figure 13.7. Material Handling Equipment Taxonomy by MHIA-CICMHE

Pipeline

A pipeline is a system of connected pipes for the transportation of liquids, gasses, and slurries. Slurries are fine solid particles suspended in a liquid. Pumps, valves, and other control devices control the flow. Products may be stored temporarily in storage tanks. Pipelines inside the facilities are usually suspended from the ceiling. Pipelines usually consist of sections of pipe made of metals, such as steel, cast iron or aluminum, concrete, or plastics. Pipelines can be used inside the facilities, on campus environments such as chemical refineries, over for long-distance transportation. Please see the section

on pipelines in the Transportation Systems chapter for more information on pipelines used in long distance transportation.

Conveyors

Conveyors are used when material needs to be move in a continuous movement over a fixed path. Conveyors have very limited access area and a very high hardware cost and are thus suitable only for very high volume operations. Conveyors can be synchronous or asynchronous. A conveyor is synchronous if all the material on the conveyor moves at the same time and at the same speed, it is an asynchronous conveyor otherwise. Examples of synchronous conveyors are belt and roller conveyors; an example of an asynchronous conveyor is an automated electrified monorail or AEM.



Figure 13.8. Bulk Belt Conveyor for Removal of Gold Mining Debris



Figure 13.9. Bulk Belt Conveyor for Removal of Wood Chips



Figure 13.10. Belt Conveyor in Electronic Assembly



Figure 13.11. Belt Conveyor with Diverter Bar in Electronic Assembly



**Figure 13.12. Automatic Order Picking A-Frame with Take-Away Belt Conveyor
(Picture courtesy of Electrocom)**



Figure 13.13. Roller Conveyor in Manual Order Picking
(Photo courtesy of Dr. John Bartholdi)



Figure 13.14. Roller Conveyor Network in Electronics Manufacturing



Figure 13.15. Roller Conveyor with Diverter in Electronics Manufacturing



Figure 13.16. Inverted Power and Free Conveyor in Automotive Assembly



Figure 13.17. Power and Free Conveyor in Automotive Engine Assembly



Figure 13.18. Power and Free Conveyor in Automotive Final Assembly



Figure 13.19. Inverted Automated Electrified Monorail in Typewriter Manufacturing

Crane and Hoists

Cranes and hoists are overhead devices that are primarily used to provide a vertical movement capability, i.e., for raising and lowering loads. There may also be a horizontal movement component usually above the factory floor and production equipment. Cranes and hoists usually have a fixed pulley, a moveable pulley with a hook or other method of attaching the load and connecting rope or cable. The material is transported in intermittent moves. Cranes and hoists have limited access areas, medium hardware costs, and are suitable for medium volume applications.

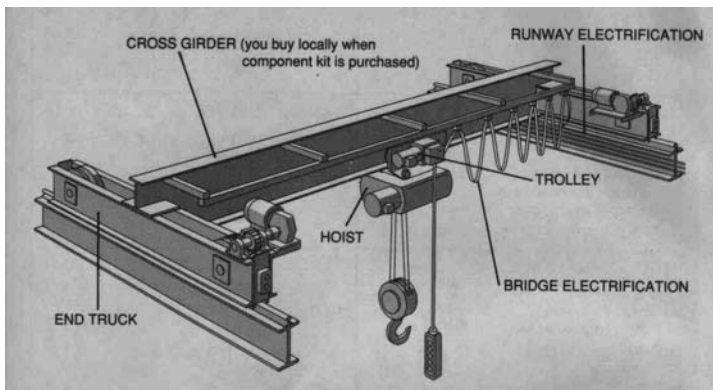

Figure 13.20. Bridge Crane



Figure 13.21. Bridge Crane for Jet Engine Assembly



Bridge cranes cover rectangular areas, while jib cranes cover circular or semi-circular areas. Bridge cranes can be hung from the ceiling, mounted on the walls, or be floor-supported. Jib cranes can be floor-supported or wall-mounted. Bridge cranes provide consistent ease of operation throughout the whole access area. Jib cranes are more easily operated when the load is at the very end of the boom and are more difficult to operate as the load approaches the pivot point.

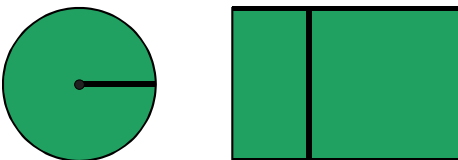

Figure 13.22. Jib and Bridge Crane Access Areas

With ceiling or wall-mounted systems, the support steel of the crane does not interfere with the handling operations. On the other hand, the cranes require a building with adequate overhead or wall structure to support the crane. Floor-supported cranes are free standing and do not put stress on the building's

overhead or wall structure. Installation of floor-supported cranes is usually more straightforward and the cranes are easier to relocate at a later time. Floor-supported cranes require a reinforced concrete floor.

When sizing a crane, the capacity should be kept to a minimum. If a crane has been over capacitated, then for each operation extra crane weight has to be moved and the support structures might have been designed to sustain larger loads than required. Long bridge crane lengths are acceptable for slower production cycles or for maintenance operations, while fast production cycles require a short crane length. Keep the bridge or crane height to a minimum to clear the operations, since lower loads are easier to control and to position.

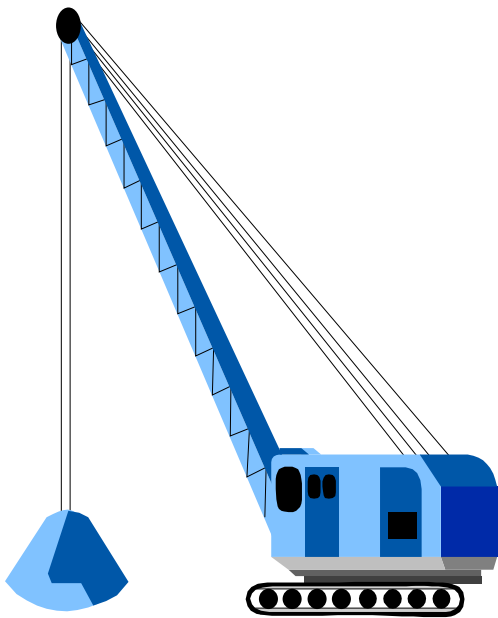

Figure 13.23. Moveable Bulk Crane



Figure 13.24. Moveable Intermodal Container Crane

Industrial Trucks

Industrial trucks are vehicles moving on wheels and excluding over the road trucks, which are described in long distance carriers. The material is transported in intermittent moves. The industrial trucks have variable paths and a very wide access area and low hardware cost. They are primarily used in low volume operations. A prominent example is the forklift truck, which is an industrial truck used for transporting a load horizontally and for elevating or lowering a load to store it.

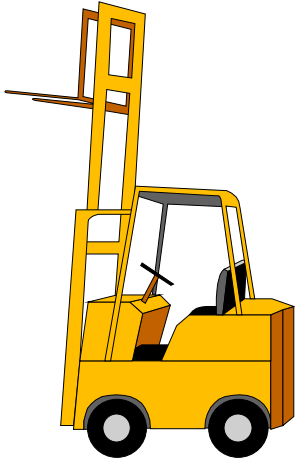

Figure 13.25. Counterbalanced Fork Lift Truck Illustration



Figure 13.26. Hand Truck

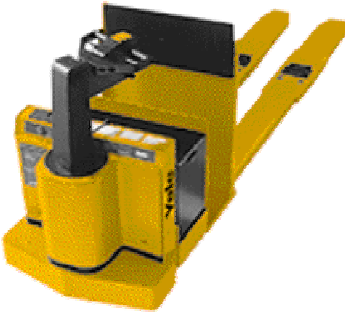

Figure 13.27. Riding Hand Truck



Figure 13.28. Tractor Truck for Trailer Trains



Figure 13.29. Tractor-Trailer Example



Figure 13.30. Tractor with Double Pallet Trailer Example



Figure 13.31. Counterbalanced Forklift Truck



Figure 13.32. Counterbalanced Forklift Truck



Figure 13.33. Narrow Aisle Straddle Truck



Figure 13.34. Order Picking Truck



Figure 13.35. Stacker Cranes



Figure 13.36. AGV with Collision Bumpers



Figure 13.37. AGV with Load Station



Figure 13.38. AGV Leaving Load Station



Figure 13.39. AGVS Interfacing with AS/RS



Figure 13.40. Multiload AGVS in Electronics Manufacturing



Figure 13.41. Multiload AGVS Interfacing with a Clean Room

Containers and Supports

The primary goal of containers is to maintain a unit load. Prime examples of containers are pallet, drum, and intermodal containers.

In the 1960s large and fast ocean-going ships were designed specifically for carrying containers above deck as well in their hold. The cargo was easily loaded and unloaded which minimized the time spent in port. The container was then transported further by rail or truck, which decreased the overall transit time of the products and avoided damage and loss in the ports. Such containers are called intermodal and except for bulk, ore, or crude products, make now up the majority of the international freight. The shift to the transportation of freight in large, standardized containers is called containerization. The ports that can handle these containers rapidly and transfer them to internal transportation systems are expensive and their operations are complex.

A significant operational concern is the management of the empty containers, especially between countries with a large trade imbalance or cargo traffic that is unbalanced.



Figure 13.42. Ocean-Going Intermodal Container Ship



Figure 13.43. Ocean-Going Intermodal Container

Storage Equipment

The primary goal of storage equipment is to store material.

Examples of person-to-part storage equipment are block stacking, pallet racks, gravity flow racks, and bin shelving. An example of a part-to-person storage equipment is a carousel.



Figure 13.44. Block Stacking Household Appliances with Clamp Truck



Figure 13.45. Shelves in a Ladder Arrangement



Figure 13.46. Order Picking from Shelves



Figure 13.47. Unit Load Pallet Rack with Pallet Jack and Straddle Truck



Figure 13.48. Quantity LED Indicators on Shelves (Pick-To-Light)
(Picture courtesy of AutoPick)



Figure 13.49. Small Parts Carousel

Auxiliary Equipment

The term auxiliary equipment is a catch all category for all other devices used in material handling, such as bar code readers, stretch wrappers, palletizers, lift tables, measuring frames, air film handling equipment, radio frequency terminals...



Figure 13.50. Pallet Positioners For Ergonomic Operations



Figure 13.51. Radio-Frequency Communications during Order Picking in Cold Storage (Picture courtesy of Vocollect)

Talkman-OPEN Wireless Architecture

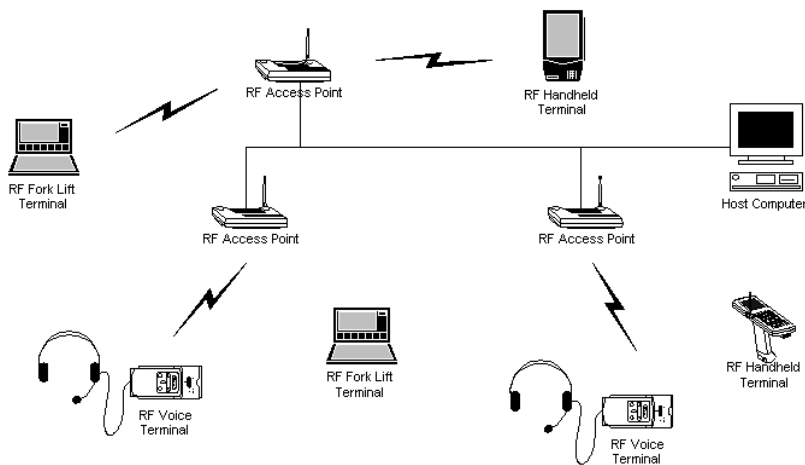

Figure 13.52. Radio-Frequency Terminal Architecture for Warehouse Communications (Figure courtesy of Vocollect)

Storage and Retrieval Systems

Storage and retrieval systems provide the combined function of handling and storage the material. Examples are unit load automated storage and retrieval systems (AS/RS) which store and retrieve whole pallets, miniload systems with storage drawers, microload systems with storage totes (sometimes also called tote stackers), and carousels with extractors. Other examples are the A and V-frame order picking systems for very high volume order picking operations. All these are examples of storage and retrieval systems where the material is moved to the input/output point. A person-aboard AS/RS is an example of systems where the picker is move to the part.

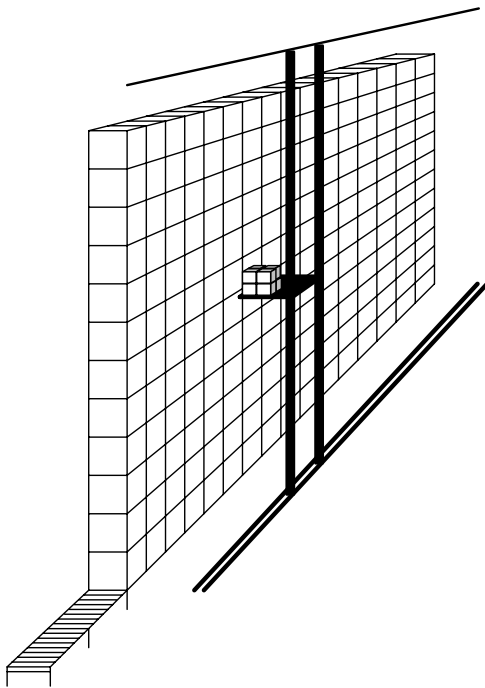

Figure 13.53. Unit Load AS/RS Illustration

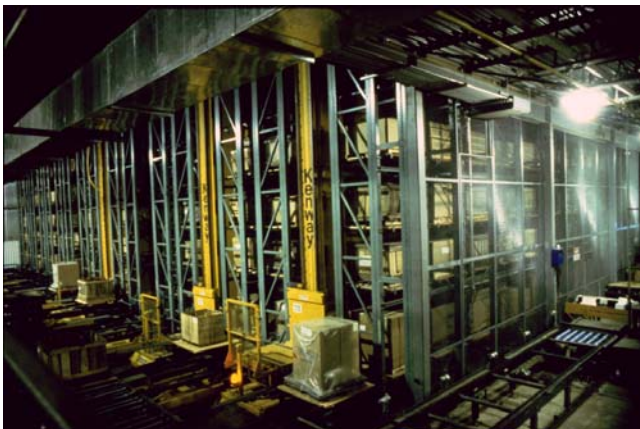

Figure 13.54. Unit Load Automated Storage/Retrieval System



Figure 13.55. Unit Load Automated Storage/Retrieval System with Baskets



Figure 13.56. Unit Load Automated Storage/Retrieval System for Paper Rolls



Figure 13.57. Unit Load Automated Storage/Retrieval System for Thread Coils

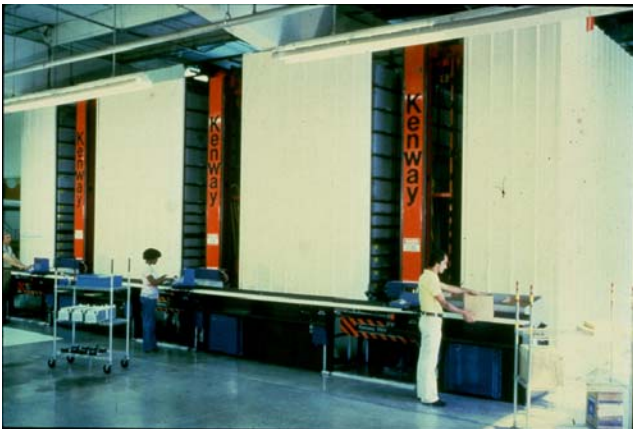

Figure 13.58. Miniload Automated Storage/Retrieval System

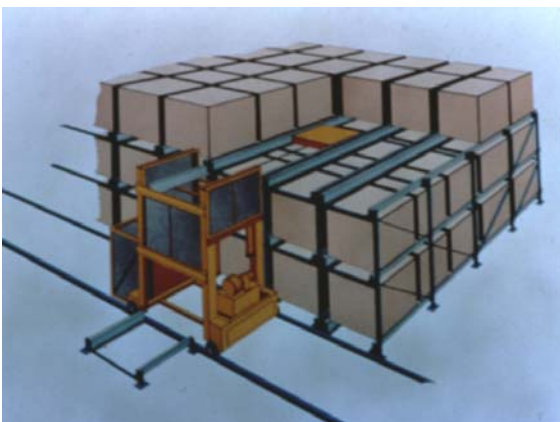

Figure 13.59. Deep Lane Storage Illustration

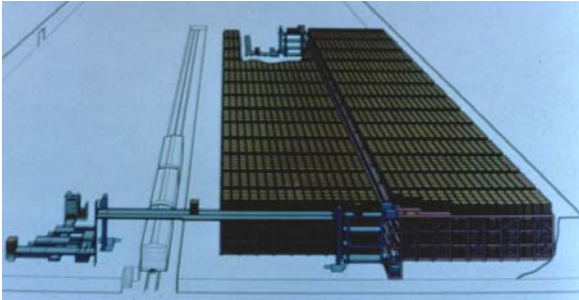

Figure 13.60. Deep Lane Storage Warehouse Illustration

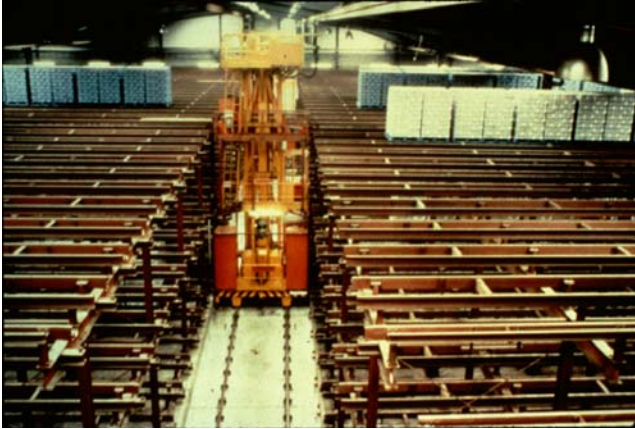

Figure 13.61. Two-Sided Deep Lane Storage Warehouse

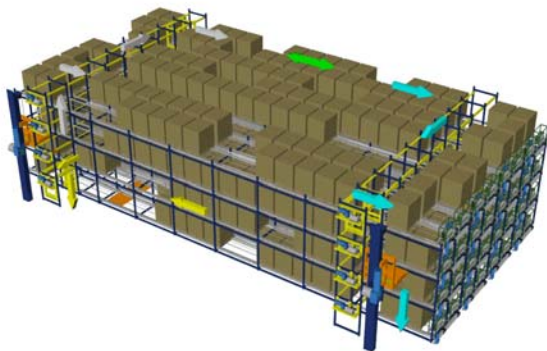

Figure 62. Deep Lane Unit Load Automated Storage Retrieval Detail (Activ System, photo courtesy of Retrotech)

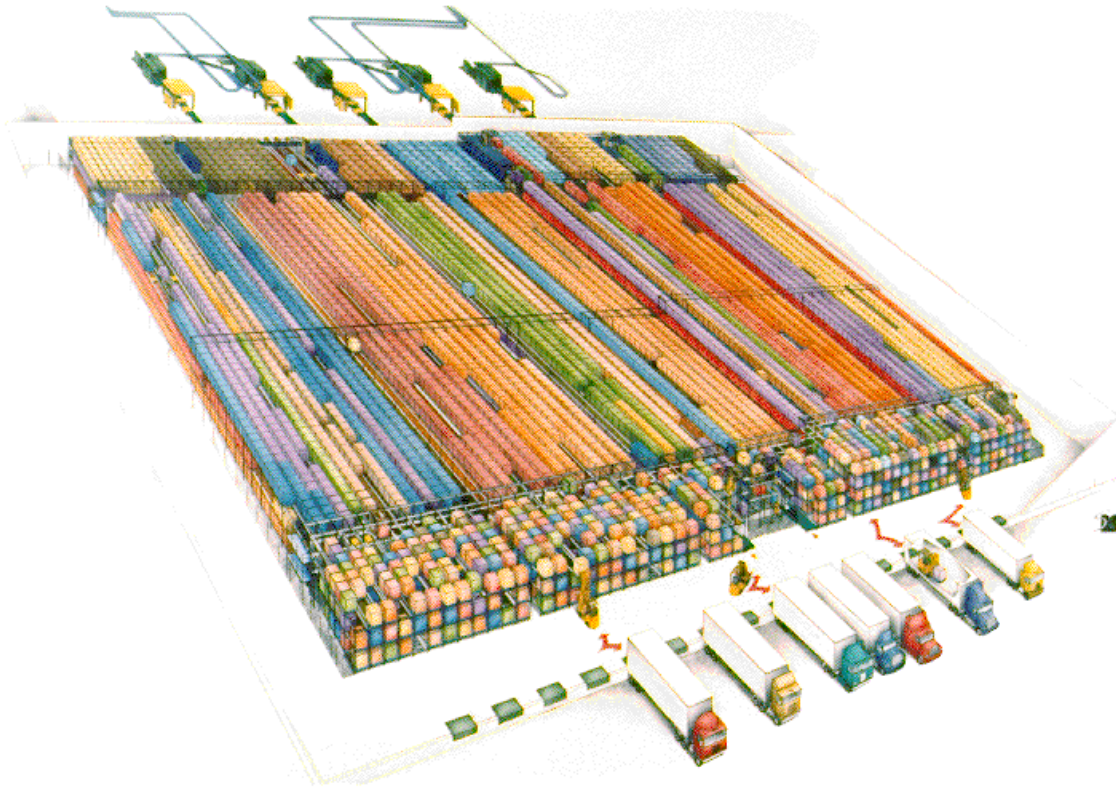

Figure 63. Deep Lane Unit Load Staging Warehouse (Activ System, photo courtesy of Retrotech)

An A-frame is an automated order picking system used for high-speed, high throughput order picking of small and well packaged items. Each order corresponds to a section of a conveyor belt running through the A-Frame and items are propelled on the conveyor belt under computer control to fill the order. The complete order is picked when the conveyor section exists the A-Frame. The A-frame has columns of boxes (mostly used for small parts such as medicines) that are pushed on a conveyor by pneumatic or mechanic pusher. It is replenished from the top and the outside.

A flow-through rack has rows of boxes (can be small parts or regular cartons), it is replenished from the back and picked from the front. Most of the time the next box is brought forward to the pick face by gravity or the boxes can be placed on an indexed conveyor (one conveyor for each SKU) and the conveyor moves one position forward when a box needs to be picked.

An A frame can be replenished during operation, but a flow-through rack with indexed conveyors must disable the picking that SKU during its replenishment. There is also a flow through rack where the parts move forward by gravity but those are typically used for manual picking.



Figure 13.64. Automatic Order Picking A-Frame
(Picture courtesy of Electrocom)

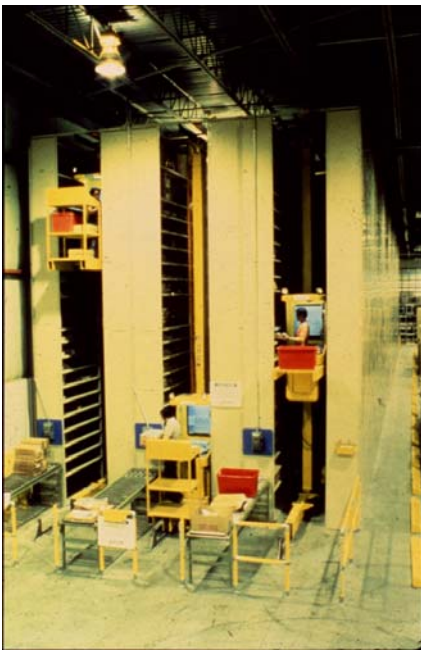

Figure 13.65. Person-Aboard Order Picking



Figure 13.66. In-the-Aisle View of Person-Aboard Order Picking

Robots

Robot is derived from the Czech word "robota" for (compulsory) hard labor. It was introduced into the English language by the science fiction literature and is now the standard term, even after many efforts to create a different term. Robots started to appear in manufacturing systems from 1960 on.

Definition

A simple definition of a robot is "*a general purpose, programmable machine possessing certain anthropomorphic characteristics*". (Anthropomorphic means human-like and usually refers to the gripper of the robot that resembles a hand). Different countries use different definitions and a universal definition is not yet established. A good introduction to robots can be found in Tanner (1981).

In the **United States**, the Robot Institute of America defines a robot as "a programmable, multifunction manipulator designed to move material, parts, tools or specialized devices through variable programmed motions for the performance of a variety of tasks".

The **European Common Market** defines a robot as "an independently acting and self controlling machine, equipped with specific tools to handle or machine and whose movements are programmable with respect to orientation, position and sequence".

The *Japanese Industrial Robot Association* has no definition for a robot as such, but defines the following six classes of robots:

1) **Manual manipulator**: a device activated and controlled directly by a person. Examples are the remotely controlled arms and hands used in the handling of nuclear or toxic materials.

2) **Fixed sequence robot**: machines mechanically coded for the execution of a fixed sequence of operations. An example is a car wash robot where all the brushes and spray guns execute every time the same sequence of operations. An industrial example is the mass assembly table used for the final assembly of consumer items such as ballpoint pens, plastic shavers, etc. The mechanical coding uses cams and levers.

3) **Variable sequence robot**: machines which have a limited set of fixed sequences of steps and where the sequence can be independently selected in a mechanical or pneumatic way or can be determined by feedback. An example is a programmable dishwasher that can execute different cycles and/or can abort a cycle based on error conditions such as a blocked arm.

4) **Play back robot**: a person teaches the robot a sequence of actions by actually taking the robot hand or pendant and making the movements. The steps are stored electronically. The programming is said to be one on-line since the robot cannot continue executing its old sequence while it is learning a new task. Examples of this class of robots are the painting and some welding robots. (This programming is comparable to teaching a baby how to eat).

5) **Numerically controlled robot**: the program to steer the robot is developed by a computer. It is transferred to the robot on a storage device such as a paper tape or floppy disk for the early NC (Numerically Controlled) Robots. Currently, the robots have an on-line communications link with the computer for a CNC (Computer Numerically Controlled) Robot or DNC (Direct Numerically Controlled or, recently, Distributed Numerically Controlled) robot. Examples of such robots are the spot and continuous welding robots. This class is probably most in use in the manufacturing industry. Programming is said to be off-line, i.e. by the computer while the robot keeps on working. Special purpose languages to program robots have been developed such as AML (A Manufacturing Language) by IBM and APT (Automatically Programmed Tools) by MIT. (This level of programming is comparable to the written assembly instructions in consumer products).

6) **Intelligent robot**: the robot reacts based on its programming and observations of the world through a sensory system. These robots are primarily used in assembly (in the electronics industry) and for inspection tasks. (This level corresponds approximately to a kindergarten level approach to problem solving). The vision system can recognize consistently two-dimensional, black-and-white objects, but only if they are completely separated from neighboring objects and contrast sharply with their backgrounds.

The first three classes in the Japanese classification are not considered robots in the European or American definition. This makes comparisons of statistics difficult. It is estimated that only 10% of the Japanese robots are robots of class 4 or higher. The statistics that follow take only in consideration robots of class 4 or higher.

Quality Characteristics

The quality or value of a robot depends largely on the following characteristics, with the first two being of overriding importance:

- 1) **Accuracy** or precision or tolerance which indicates how close the mechanical machine comes to the theoretical, programmed point
- 2) **Repeatability** or consistency which indicates the percentage that the mechanical machine arrives within its tolerance when it repeatedly has to visit the same programmed point
- 3) The reach or access area of the robot, also called the size of the work envelope
- 4) The net load carrying capacity of the robot at the end of the arm so that the robot stays within its tolerances
- 5) The movement speed of the robot

Robots Configurations and Characteristics

Degrees of Freedom

Robots can have up to six degrees of freedom, three for the robot arm and three for the gripper, plus one additional degree of freedom for opening and closing the gripper. The gripper or wrist degrees of freedom are called pitch (vertical rotation through the axis of the arm), yaw (horizontal rotation through the axis of the arm), and roll (rotation around the arm axis). To imitate human movement six degrees of freedom are required.

Power Supply Types

Robots can have pneumatic, hydraulic or electric power supplies. The more recent robots mostly have electric direct drive engines at the joints of the arm.

Robot Configurations and Associated Work Envelopes

Robots can be configured as polar, cylindrical, rectangular or Cartesian, and jointed arm or revolute. The work envelope for a polar robot is a hemisphere, for a cylindrical robot a cylinder, for a Cartesian robot a box, and for a revolute robot a cylinder with a dome.

Robot Applications

Robots are primarily used in the three D's areas, i.e. to execute dangerous, dull or dirty work. Most robots are used for spot welding (up to 40%), continuous or arc welding (8%), pick and place operations such as machine loading/unloading (23%), and spray painting (14%). The major user of robots is the automobile industry (up to 70% of all robots). The newer, more sophisticated robots are used for electronic component assembly and inspection in the electronics industry.

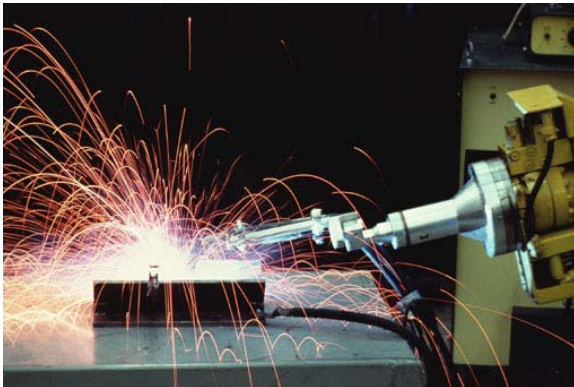

Figure 13.67. Welding Robot



Figure 13.68. Pick and Place Robot



Figure 13.69. Robotic Spray Painting in Automotive Assembly



Figure 13.70. Robotic Assembly



Figure 13.71. Robotic Part Loading in an Automated Machining Cell



Figure 13.72. Robotic Part Unloading with Vacuum Gripper

Future Developments

The development of a truly (artificial) intelligent robot (class 7 if the Japanese classification system is extended) is very closely related to the development of the fifth generation computer. An intelligent robot must have the ability to learn or understand from experience and to respond successfully to a new situation; it must be able to make judgments, associate relevant information and synthesize new knowledge from such associations, and reach wholly unique and accurate conclusions for a given situation. Required future developments are:

Enhanced sensory systems such as three-dimensional vision with pattern recognition and proportional tactile feedback.

Voice programming and verbal response to commands on the manufacturing floor.

Natural Language programming so that the robot will be able to understand English.

Artificial intelligence, so that such a robot would be able to learn from its own previous experience and be able to combine programming, experience and feedback.

This futuristic, class 7 robot corresponds to an elementary school level approach to problem solving. An example of such a robot is HAL in the movie "2001: a space odyssey".

Statistics

Table 13.3 lists the robot density (number of robots per 10,000 laborers) and the end of 1983 and the robot growth for the year 1983, (Technivisie, Vol. 2, No 24, April 1984). Table 13.4 provides some data at the end of 1988, (Technivisie, Vol. 7, No 24, April 1989)

Table 13.3. Robot Densities by Country in 1983

Country	Robots	Labor Force	Density	Growth
Sweden	1,900	1,352	14	----
Japan	16,500	19,556	8.4	27%
W. Germany	4,880	11,334	4.3	39%
Belgium	514	1,332	3.9	42%
G. Britain	1,753	5,272	3.3	52%
USA	8,000	29,774	2.7	23%
Italy	1,800	7,787	2.3	----
France	1,500	7,574	2	57%

Table 13.4. Robot Densities by Country in 1988

Country	Robots	Labor Force	Density	Growth
Sweden	1,900			15%
Norway				9%
Poland				8%
Japan		143,000		27%
Belgium	1,232			10%
Netherlands	747			19%
USA	29,000			16%
Singapore				132%
Taiwan				35%

Advantages and Disadvantages of Robots

The primary advantages of the robot are

1. Its **quality consistency**: day in, day out the same uniform product makes quality control and scheduling easier.
2. Its **cost per hour**: a robot cost about \$6 per hour versus \$25 to \$40 per hour for a skilled laborer. The purchase price of robots ranges from \$25,000 to \$200,000. Moreover, robots can work continuously during the whole day and the whole year, which is a necessary requirement to increase the utilization of the factories.

The primary disadvantages of robots are

1. The capabilities of robots are still limited versus the flexibility of a laborer, which makes robots only applicable for mass production or for flexible manufacturing systems with its very large family batch sizes.
2. There could develop future social problems from the use of robots with respect to employment. Robots eliminate the traditional middle class manufacturing jobs and only leave the very high level engineering jobs and the low skill service jobs. A study by the Society of Manufacturing

Engineers states that robots will displace about 4 percent of the nation's manufacturing workers during the remainder of the century, while at the same time creating 50,000 robotics related jobs. This is not a current problem due to the very small percentage of robots in use. Moreover, most corporations have started massive retraining programs to help their employees adapt to the changing job requirements.

Long Distance Material Handling

Long distance material handling carriers include land, sea, air, and space transportation vehicles. Land transportation uses automobiles, trucks, trailers, rail cars, or unit trains. Sea transportation equipment includes self-propelled ships, container carriers, barges, and supertankers. Air transportation equipment includes planes and space transportation relies on reusable space shuttles and single use rockets.

The choice of transportation system is usually based on a tradeoff between volume capacity, shipping time, and cost. Air transportation is the quickest, but the most expensive and with the smallest carrying capacity. As a consequence it is mostly used for small packages and when inventory costs are especially high. Land transportation provides the greatest flexibility, especially when trucks are used. Rail transportation is has a larger carrying capacity than trucks but requires a larger shipping time and transshipping from one vehicle to another. A new hybrid system is piggyback, where truck carriers are placed on flat bed rail cars for the long distance segment of the trip and picked up and delivered by trucks at the origin and destination points. Water and sea transportation systems have very high carrying capacity but are usually slower than other transportation means.

For a more detailed discussion of long-distance carriers see the chapter on Transportation Systems.

Exercises

References

1. Kulwiec, R. A. (ed.), (1985), **Materials Handling Handbook**, 2nd Edition, Wiley-Interscience.
2. Matson, J. O., Swaminathan, S. R., Mellichamp, J. M., "Knowledge-Based Material Handling Equipment selection," Proc. of the 1990 International Industrial Engineering Conference, 212-217, (1990).

3. Material Handling Institute of America, Charlotte, NC, www.mhia.org.